

FIG.1

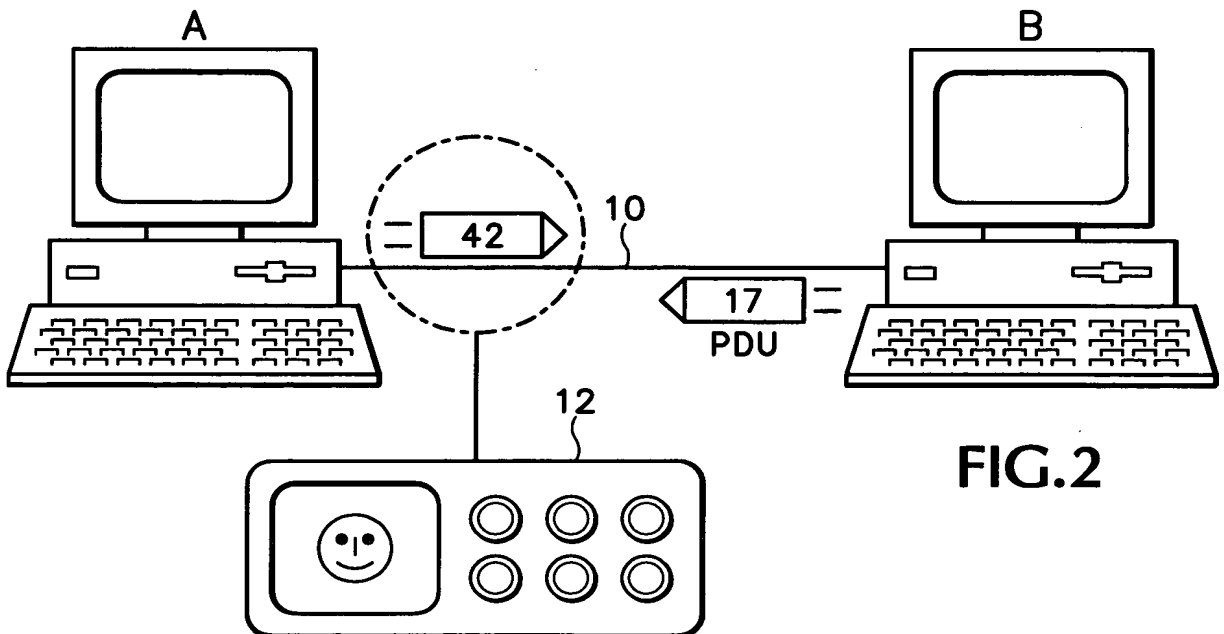

FIG.2

2/5

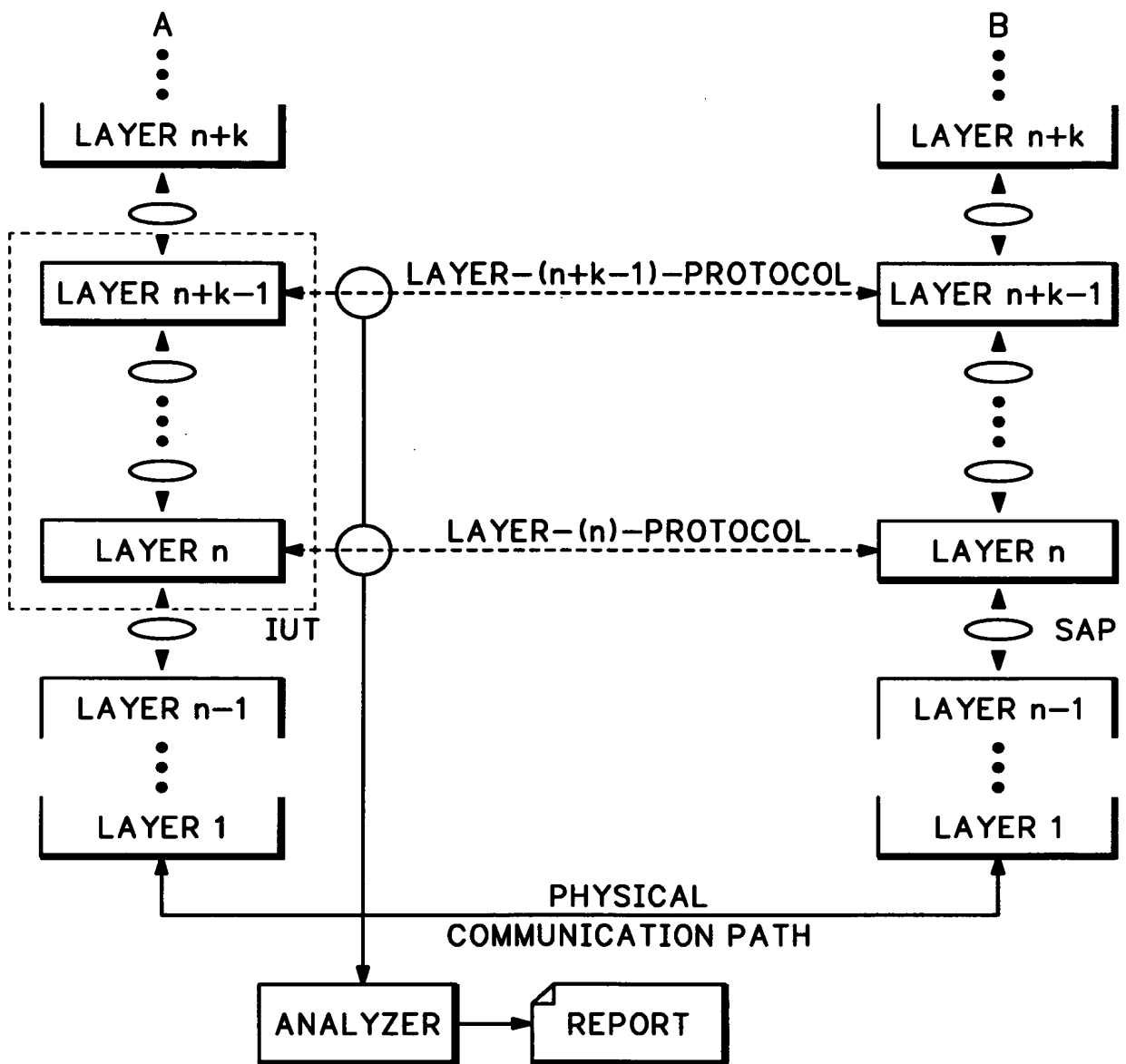

FIG.3

3/5

a (x,y)

BYTE		
1 - 2	42 (ACK)	a
3 - 6	TELEPHONE NUMBER RECEIVER	x
7 - 10	TELEPHONE NUMBER SENDER	y

**FIG.4**

a   b   a   b   a   c   b   a   c   b   a   b   a   b   a

1   2   3   4   5   6   7   8   9   10   11   12   13   14

**FIG.5**

	1	2	3	4	5
1	$\infty$	0	3	0	① ← ③
2	0	$\infty$	0	3	0
3	3	0	$\infty$	0	3
4	0	3	0	$\infty$	0
5	① ↑ ③	0	3	0	$\infty$

**FIG.6**

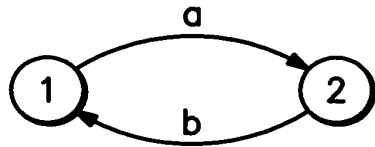

FIG. 7

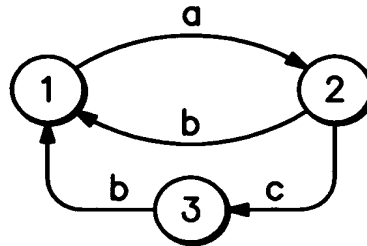

FIG. 8

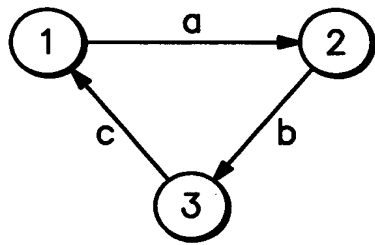

FIG. 9

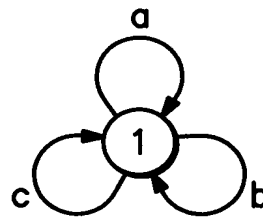

FIG. 10

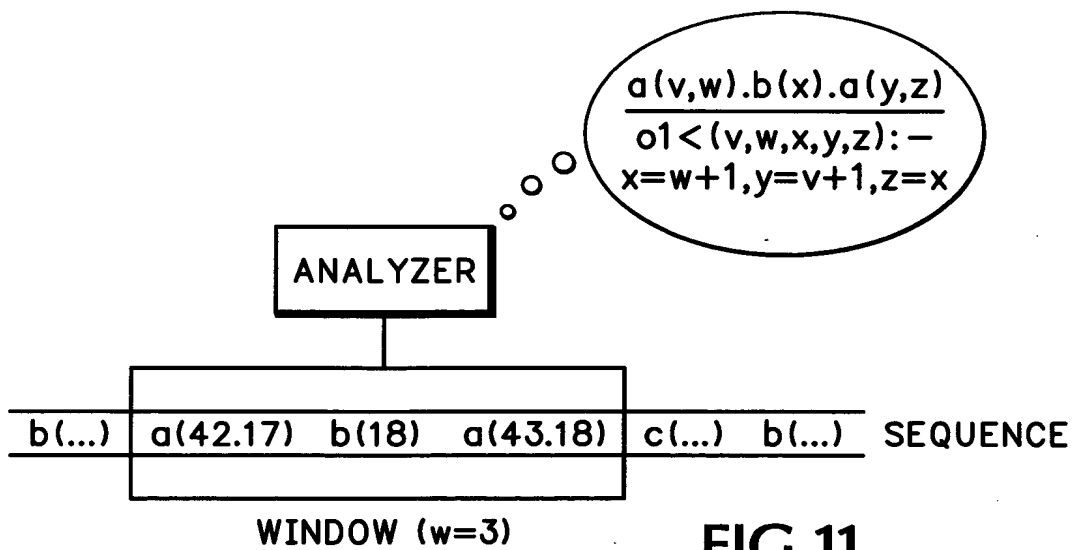

FIG. 11

v	w	x	y	z	y - v	x - z
42	17	18	43	18	1	0
100	307	308	101	308	1	0
⋮	⋮	⋮	⋮	⋮	⋮	⋮
⋮	⋮	⋮	⋮	⋮	⋮	⋮

FIG.12



FIG.13